

USER MANUAL

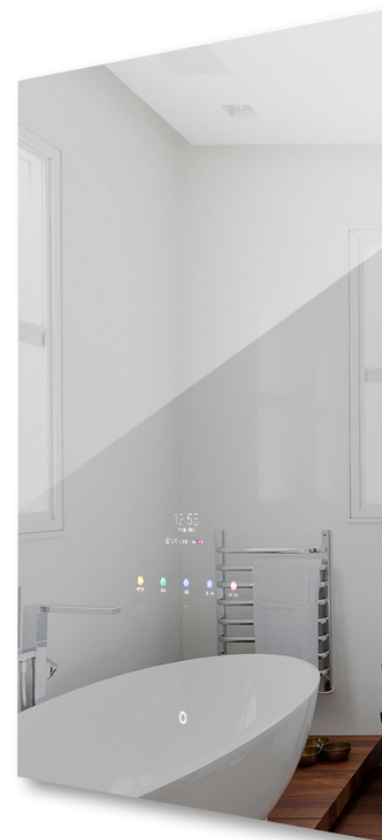

MODEL:KY600\KY700\KY800\
K5070\K6080\K1275\K1580

BATHROOM
SMART MIRROR

CONTENTS

DELIVERY SCOPE.....P1

INSTALLATION.....P2-P3

SETUP.....P4-P12

PRODUCT SPECIFICATIONS.....P13-P14

ABOUT THIS MANUAL.....P15

ELECTRICITY SAFETY.....P16

SAFETY PRECAUTIONS.....P17-P22

USER WARRANTY.....P23-P24

Package Including

Components may differ in different locations.
 Contact the vendor where you purchased the product if any components are missing. The appearance of the components may differ from the images shown.

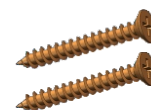

Screw *2

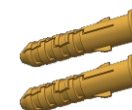

Expansion screw*2



Power wire

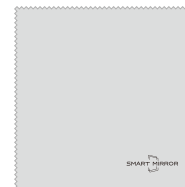

Cleaning Cloth *1



Instruction book*1



Skin Tester * 1
(optional)



Body Fat Scale *1
(optional)

Bathroom Protection Areas

For installations in wet-rooms, such as bathrooms, specific installation guidelines apply. These regulations differ by region. Please contact a specialist for this. Therefore electrical installations are to be performed by a skilled technician.



This product is subject to protection class IP65. This protects the product against splashing water from any angle.

Product installation

1. The distance between the two holes for installation is A, and the height from the ground B must be the same. Measure the installation location and mark it. (For the specific size of A and B, please refer to the size table according to the product model, and the installation height according to the size table, the bottom of the mirror from the ground is 1100mm)

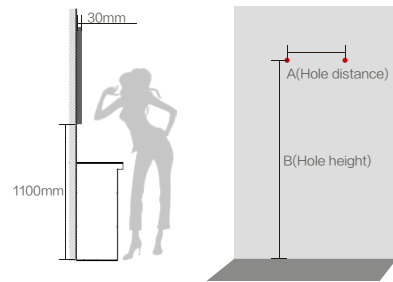

Product installation size table

Model	Size (mm)	A	B
KY600		350	1530
KY700		400	1630
KY800		500	1680
K5070		300	1720
K6080		400	1820
K1275		1000	1770
K1580		1340	1785

2. Punch two 8*40mm mounting holes in the marked position, knock the expansion tube into the hole, and the end of the expansion tube is flush with the wall, and install 2 screws into the expansion tube.

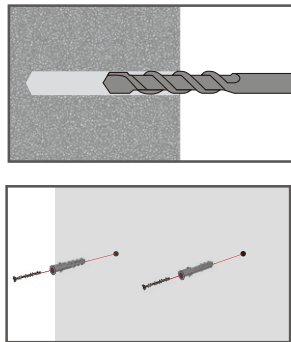

3. Fasten the inverted buckle behind the smart bathroom mirror with the screws fixed on the wall.

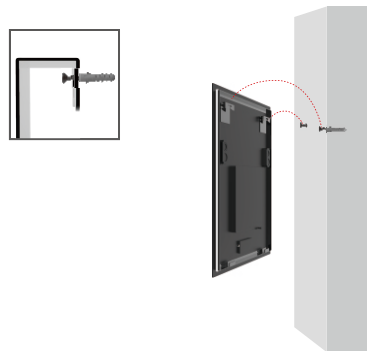

Note: The load-bearing capacity of the installation wall should be no less than four times the actual load-bearing capacity of the product.

Bathroom Protection Areas

Just power on(if there is socket behind the mirror, please connect power first and then hang the mirror on the bracket)

To guarantee electric safety and stability of functions during use, please ensure that the product is effectively grounded.

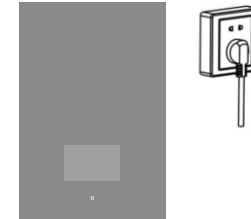

Important notes:

If the 86 line box is installed on the wall behind the smart mirror, it is a must for professionals to cut off the AC cord plug and connect the power supply by wiring.

Note the following:

- 1.Wiring operators must be certified electricians.
- 2.The main gate must be shut down during wiring operation. Power-on is strictly prohibited.
- 3.Undocumented personnels are strictly prohibited to operation by themselves.

AC wire trimming wiring instructions

1. Cut off the power cord plug according to the actual length required.

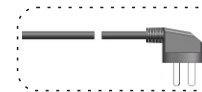

2. Strip off the black insulating layer on the outside to avoid damaging the insulating layer of the inner cable when stripping.Strip the insulation layer of the inner cable to avoid damaging the core when stripping.



3. Wiring

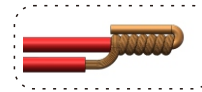

4. Insulation treatment.

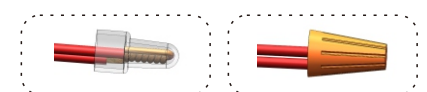

Note: A crimping cap with regular insulation and flame retardant must be used for insulation.

Get started with new smart mirror

Long press "O" for 3 seconds until the logo button turn white, (Long press 3 seconds again will turn off the mirror.)

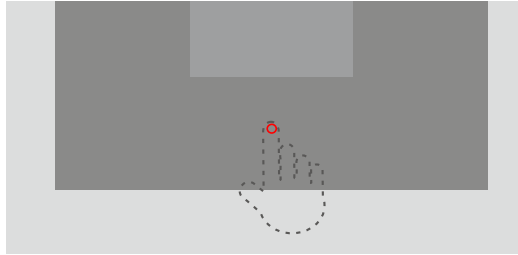

Select language

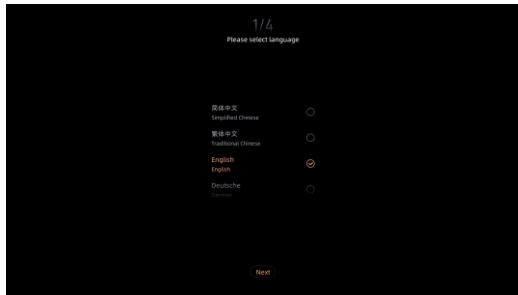

Select time zone

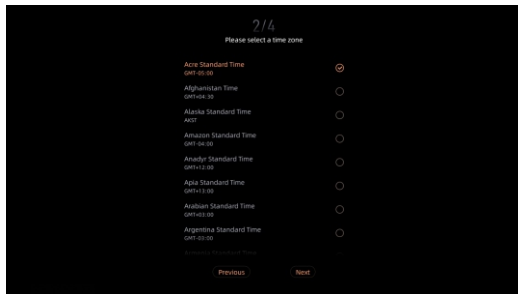

Turn on and connect to WiFi

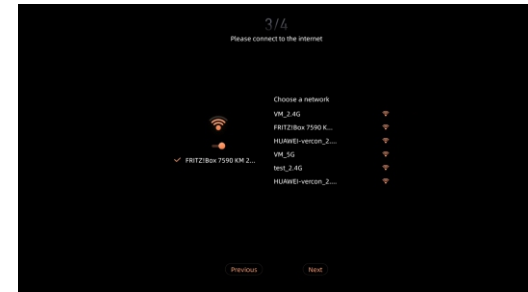

Input and select location to get weather information

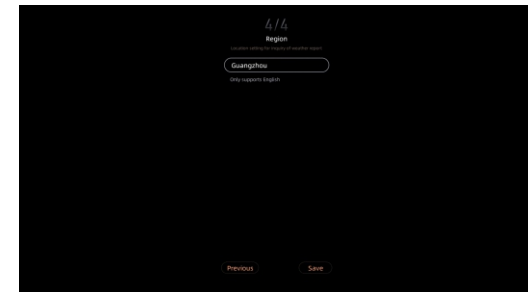

Essential operation tutorial by following hand gesture

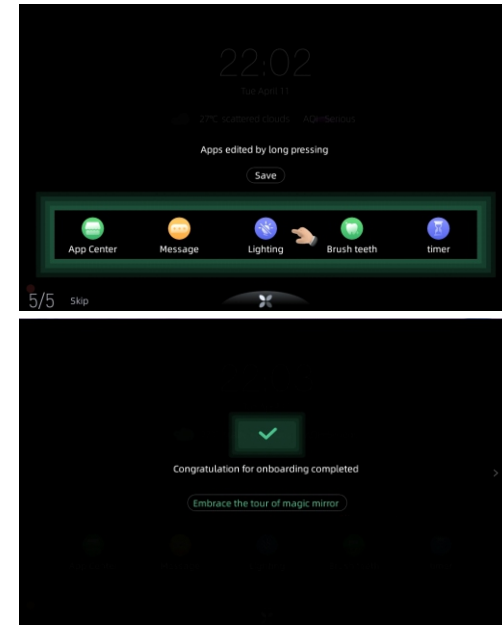
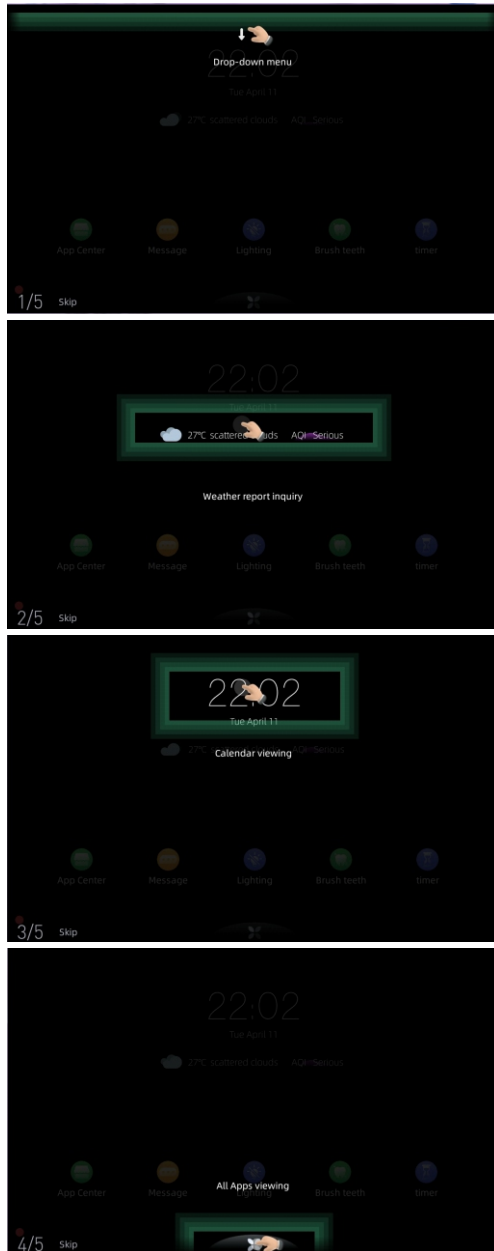

Drop-down menu

Drop-down menu can be opened in any page of smart mirror by sliding down from the top of touch screen. In shortcut cards it can control speaker volume and lighting and get quick access to functions and settings.

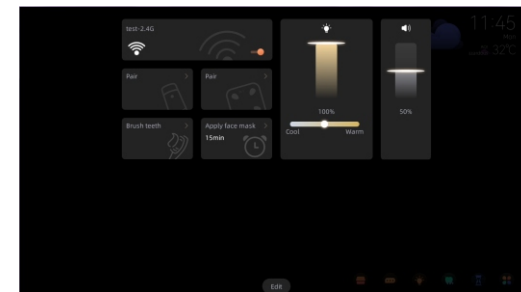

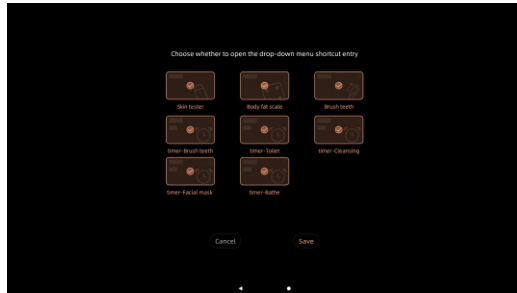

Body fat scale measuring:

1. Click **Pair** to bind body fat scale;
2. Stand on the body fat scale;
3. Select body fat scale to bind;
4. Begin to measure after binding successfully.

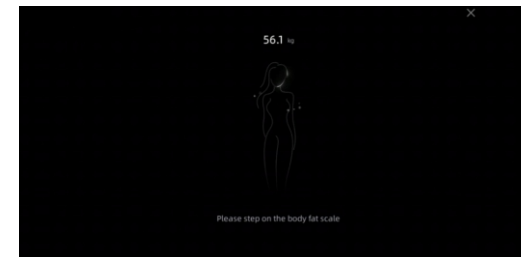
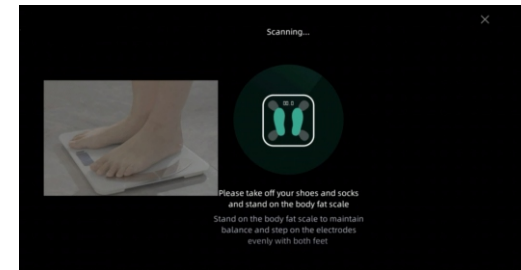
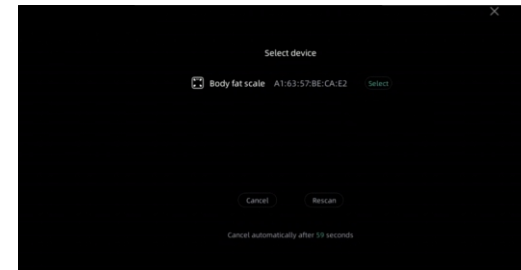
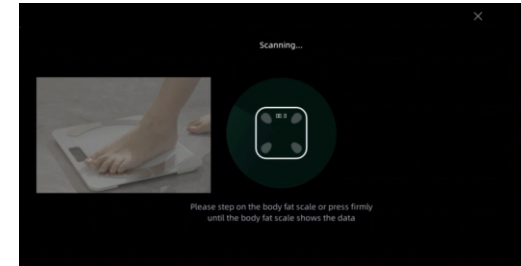
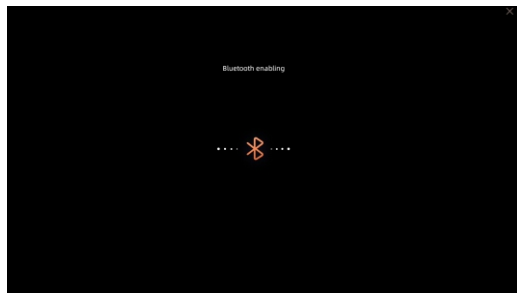
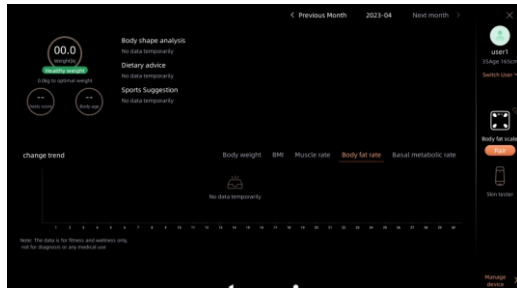

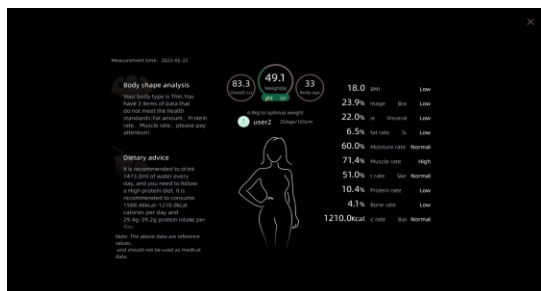

Skin detector measuring:

1. Click **Pair** to bind skin detector;
2. Push the bottom button of skin detector and the indicator light turn to green;
3. Select skin detector to bind;
4. Push the bottom button again to open skin detector, and choose body part to measure.

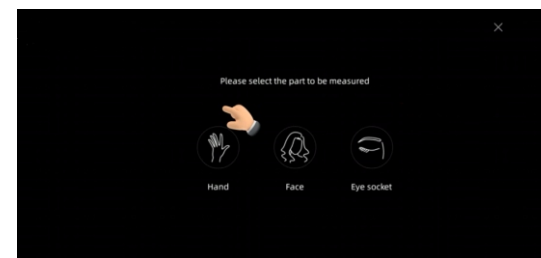
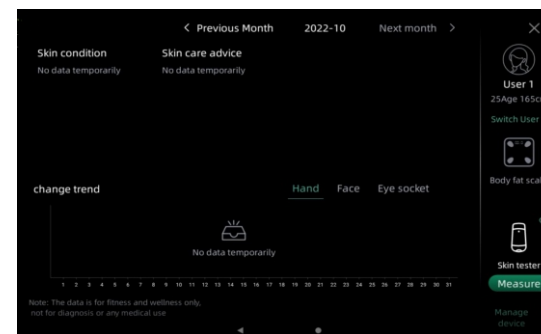
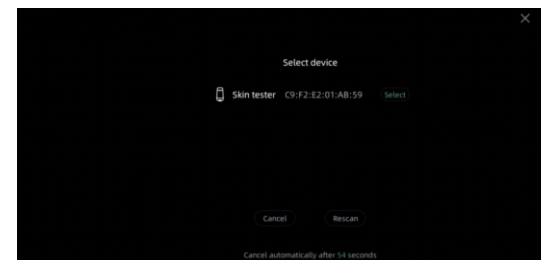
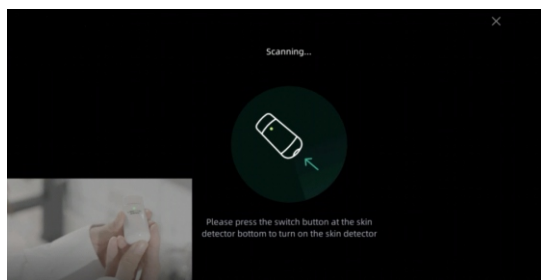
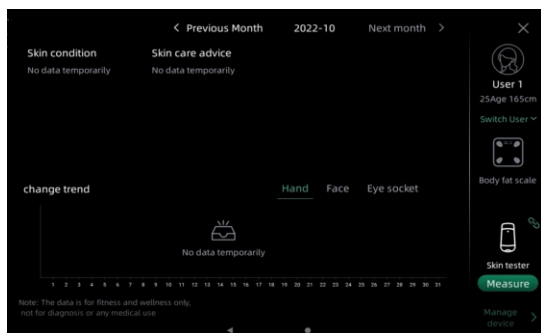

1. The measuring is continuing when indicator light is blue, and keep a close contact with the skin until measuring done.
2. View the analysis report after measuring done.

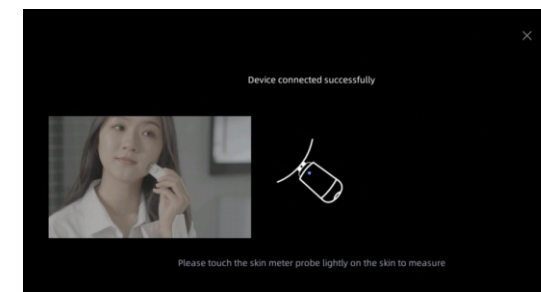

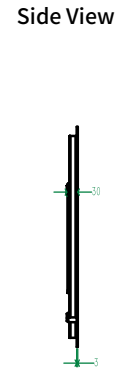
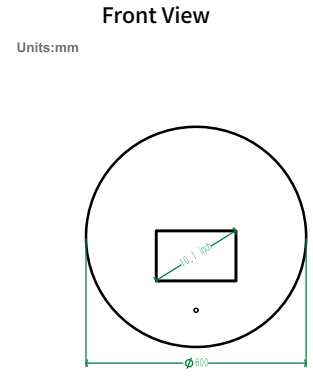
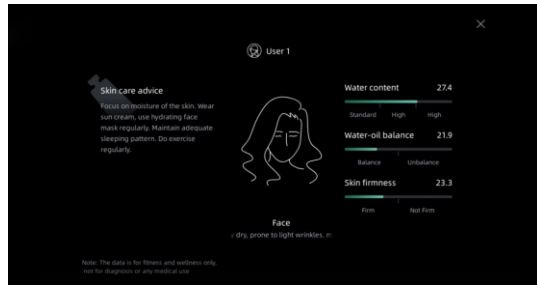

KY600

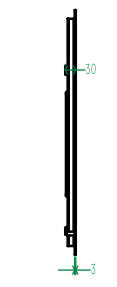
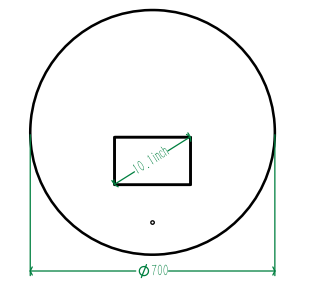
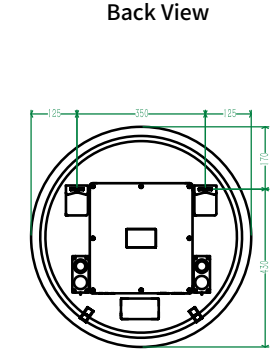

KY700

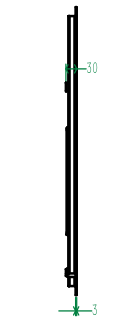
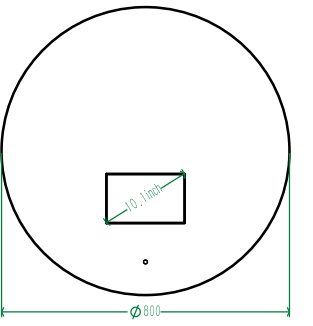
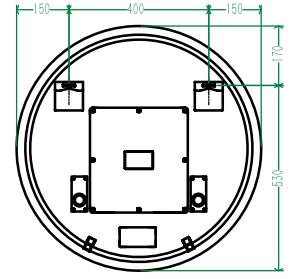

KY800

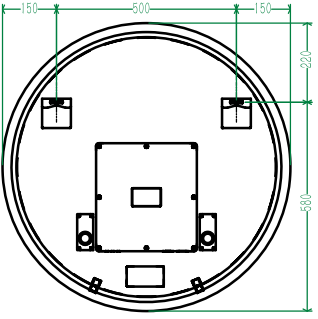

Front View

Side View

Back View

Units:mm

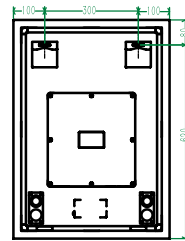
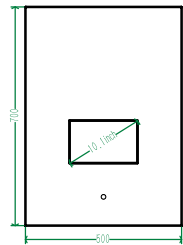

K5070

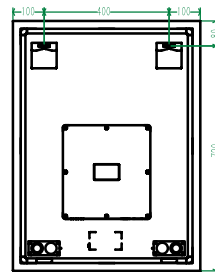
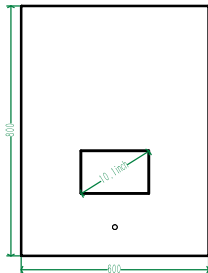

K6080

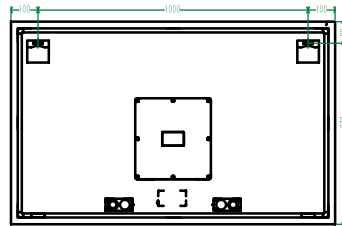
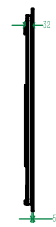
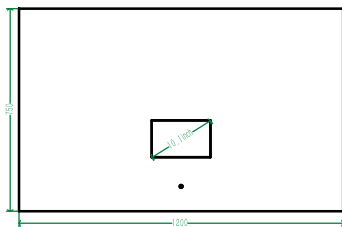

K1275

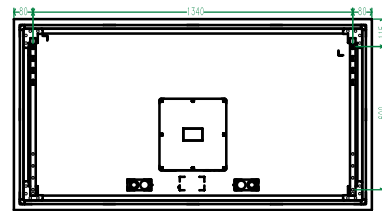
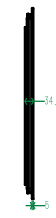
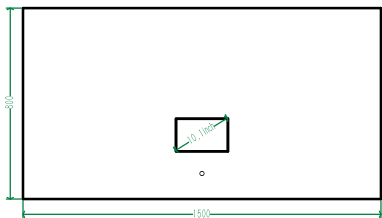

K1580

Product configuration:

Screen size: 10.1inch/21.5inch
 Resolution: 1280*800/1920*1080
 Luminance: 280nit/250nit
 CPU: VERCON-A99
 GPU: PowerVR Ge8300
 RAM: 2GB
 ROM: 32GB
 OS: Android 11
 WIFI: IEEE802.11 b/g/n a/ac
 Bluetooth: 5.0BLE
 Color Temperature: 3000K-6000K
 Speaker: 8Ω3W*2 High-Fi speaker with black sound

Power supply: AC100V-240V
 Rate power: ≤30w
 standby power: ≤4w(in the case of not turning on the ambient light)
 Operating Temperature: 0°C ~60°C
 Relative Humidity: 0%-80%
 Storage Temperature: -20°C to 80°C

Safety Specification:
 IP44 Dustproof and waterproof
 Meet CE/FCC/ROHS/CCC Standards

Warranty

Only the warranty provisions set out in the enclosed warranty certificate apply. Please pay particular attention to the information on the waiver of warranty

Terms of Use and Guidelines

Before using the product, please read the conditions Please also read all the rules, notices, and policies related to the product and related services, including, but not limited to, the privacy policy, as well as any other policies or terms of use. All conditions, rules, references, guidelines and disposals are collectively referred to as the Agreement.

When using this product, you agree to the terms of the agreement

About this manual

Please read the corresponding instructions of this manual prior to the first usage of the device, even if the usage of electronic devices is familiar to you. Notice especially the chapter SAFETY PRECAUTIONS.

Please do keep this manual in a safe place for future references.

When selling the device or giving it away, absolutely give these directions for use.

Copyright

The contents of this manual are subject to change without notice to improve quality.



An administration fee may be charged if either

- an engineer is called out at your request and there is no defect in the product (i.e. where you have failed to read this user manual)
- you bring the unit to a repair centre and there is no defect in the product (i.e. where you have failed to read this user manual)

The amount of such administration charge will be advised to you before any work or home visit is carried out.

Symbols



WARNING

A serious or fatal injury may result if instructions are not followed.



CAUTION

Injury or damage to property may result if instructions are not followed.



NOTE

Instructions followed by this symbol must be followed.



1. Never remove the housing covers or modify the product in any way. This can cause an electric shock or burn you.
2. Do not overload wall outlets, extension cords or adaptors above their capacity, since this can result in fire or electric shock.
3. Immediately cut power, if you notice that your product emits smoke, smells burnt or emits unusual noises and ask your specialist dealer for advice.
4. Do not allow the product to come into direct contact with liquids. Liquid in the housing can cause a fire, electric shock or damage the device. Immediately cut the power, if an item or liquid gets into the housing.
5. Only qualified specialist staff may carry out service tasks. Service work is necessary, if the unit has been damaged, e.g. if the mains plug or mains cable have been damaged, if liquid or items are present inside the device, if it has been exposed to rain, if it does not work properly or if it has fallen down.
6. Never touch uninsulated parts of the plug, if the device is connected to the power supply!
7. The device may only be operated with the provided power pack. The rated voltage is 100 – 240V ~ 50Hz. Use only cables suitable for your local power supply. Install the mains cable in such a way that it does not obstruct anyone. Ensure furthermore that the cable is not clamped, in particular at the plug, at the female connectors and where it exits the device. Do not install the mains cable in the proximity of heating elements and never place heavy items on the cable. Do not modify or arbitrary repair the mains cable.
8. Do not use any power cords or adapters other than those provided with this product! Use of power cords or adapters other than those provided with this product may cause fire, electric shock or malfunction.
9. The device is rated to be connected to a mains with rating max. 16A. The electrical installation need to be protected with 30 mA.
10. Never cut or damage the power cord!
11. Please disconnect the device from the power supply in the following cases:
 - The device is out of use for a lengthy period.
 - The device malfunctions or displays other unusual features, necessitating maintenance work.
 - During a thunderstorm or lightning.
12. Do not use multiple products with a single power socket.

CAUTION
RISK OF ELECTRIC SHOCK – DO NOT OPEN

Caution: to reduce the risk of electric shock, do not remove cover (or back). There are no user serviceable parts inside. Refer all servicing to qualified personnel.



Installation

1. Avoid direct sun exposure, direct proximity to heat sources, outdoor installation or storing in a car. The product is specifically designed for indoor use only. There is the danger of fire and of electric shocks and damage to the device, if it is operated outdoors.
2. Do not place candles, insect repellants or cigarettes on top of the product. Do not install the product near to heat sources.
3. Keep the plastic packaging out of reach of children, children may suffocate.
4. Keep out of reach of children. Failure to observe this precaution could result in injury.
5. Edible oil, such as soybean oil, can damage or deform the product. Do not install the product in a kitchen or near a kitchen counter.
6. Do not drop the product while moving.
7. Do not set down the product on its front (glass side) or corners.
8. Set down the product gently.
9. Structural measures must be accomplished for an on-wall installation. We decline any liability for the screws and screw anchors used on site.
10. The product is engineered vertical use only. Verify walls verticality and items vertical and horizontal alignment to prevent serious injuries and product damage.
11. Do not install the product alone on yourself. Two persons are required to perform a safe installation.
12. The corners and edges of the glass are very delicate. Take care that they do not hit the wall, ceiling or floor in any way to avoid damages and split-offs.
13. The surface of the glass is very sensitive. Do not use a cutter or knife to remove the protective foil in order to avoid scratches and other damages.
14. The product is delivered with a protective film covering the glass in order to avoid scratches and damages. Only remove the protective film once the product is installed and hanging safely on the wall.
15. Installing the product in an unusual place (a place exposed to a lot of fine dust, chemical substances, extreme temperatures or a significant presence of moisture, or a place where the product will operate continuously for an extended period of time) may seriously affect its performance and lifetime.
16. Parts of this product are made out of glass. Handle with care to avoid injury or damage. Always wear safety shoes and gloves when handling the products or its packaging.

17. There are numerous types of wall and structures, that's why we can not provide the fittings, screws and anchors for your wall. First determine the type of wall to which you want to attach the product in order to buy the appropriate fittings, screws and anchors.

18. Mounting this product requires structural measures and special skills. Refer exclusively to qualified personnel. Electrical connections must be performed by qualified professionals expecting national regulations and standards.

19. For installations in wet-rooms, such as bathrooms, specific installation guidelines apply. These regulations differ by region. Please contact a specialist for this. Therefore electrical installations are to be performed by a skilled technician, while observing the regulations of the standard DIN VDE 0100 T.701.

20. This product includes heavy, bulky and delicate items. To prevent damages to your product or injury to yourself or to others, prepare the installation environment properly. Clean the handling and installation environments properly before installation. Before installation cushion the floor properly using soft anti slip mats near the handling areas. Lay the items gently on these cushioned anti slip surfaces when needed.



Operation

1. There is a high voltage inside the product. Never disassemble, repair or modify the product yourself.
2. Before moving the product, disconnect the power cable.
3. If the product is dropped or the outer case is damaged, disconnect the power cord. Then contact the service center.
4. Do not drop objects on the product or apply impact.
5. If a gas leakage is found, do not touch the product or power connection. Also, ventilate the area immediately.
6. Do not use or keep combustible spray or an inflammable substance near the product.
7. Do not insert metallic objects (chopsticks, coins, hairpins, etc) or objects that burn easily (paper, matches, etc) into the product.
8. Do not place objects containing liquid (vases, pots, bottles, etc) or metallic objects on top of the product.
9. Leaving the screen fixed on a stationary image for an extended period of time may cause afterimage burn-in or defective pixels.
10. Do not hold the product upside-down.
11. Do not use humidifiers or stoves around the product.
12. Store small accessories out of the reach of children.

13. Do not place heavy objects (e.g. decor frames) on the product.
14. Be careful that children do not place the battery in their mouths when removed from the remote control. Place the battery in a location that children or infants cannot reach.
15. If children have had the battery in their mouths, consult your doctor immediately
16. When replacing the battery, insert it with the right polarity (+/-).
17. Use only the specified standardized batteries, and do not use a new battery and a used battery at the same time.
18. The batteries are not ordinary refuse and must be returned for recycling purposes. You are responsible for returning the used batteries for recycling. You can return used batteries to a nearby public recycling centre or to a store selling the same type of the battery.
19. Trouble free operation is ensured up to 80% air humidity. To prevent fire or electric shock, never allow liquids to enter the unit.
20. The ambient temperature for operating the device is between +5 and +40 degrees Celsius. Do not install the device in the proximity of heat sources, such as heating pipes, heaters, furnaces or other devices, which radiate heat. It is not absolutely necessary to provide air circulation to dissipate the heat.
21. All maintenance and/or service tasks, as well as repairs may only be carried out by trained customer service personnel.
22. Never let children use electrical devices unsupervised. Children can't always recognize properly the possible dangers.
23. This appliance is intended solely for private domestic use and may not be used for industrial and commercial purposes. We exclude liability in principle if the device is not used as intended, or unauthorized modifications have been made.
24. Packaging and packaging aids are recyclable and should principally be recycled. Packaging materials such as foil bag and cover foil must be kept away from children.



Operation

The product must be stored in dry and well-ventilated rooms, without extreme temperature fluctuations. Heat sources and aggressive active substances may not be stored in the proximity of the device. The required storage temperature is 0° C – +60° C at an air humidity of 5 – 85% RH. The device must be stored in the complete packaging, as delivered.



Home network and Wi-Fi requirements for bathroom application

Overview:

Bathrooms are usually enclosed by walls which cause attenuation. Rooms, on the other hand, have windows which allow cellular/Wi-Fi signal to enter and propagate more easily.

Bathrooms might have metal sheet on the door to prevent its wood from getting soaked. This reflects away most of the RF signal.

There is a network of pipes which impedes signal and creates multi-path

Water (and moisture) absorbs radio signal at higher frequencies. This is why microwave ovens operate at ~2.4GHz, which incidentally is the same as WiFi

Minimum Requirements:

You will need a high-speed DSL/Cable modem, or fiber-to-the-home broadband connection for proper playback of Internet-based music and video services.

If your Internet service provider only offers Satellite Internet access, you may experience playback issues due to fluctuating download rates.

In order to take advantage of Smart Mirror's automatic online updates, or stream music and video from an Internet-based content provider, you must install a wireless router in your home network.

If you do not have a wireless router, purchase and install one before proceeding

Please make sure your router, modem and/or wireless network specifications meet the followings:

Wireless Network Specifications: Open, WEP, WPA-PSK or WPA2-PSK encryption. Wireless Router/Modem Specifications: B,G or N routers on 2.4GHz

Connect a Wi-Fi Range Extender to your Wi-Fi system if:

- You have a larger home where the WiFi performance isn't reliable and you want to strengthen the wireless reception in your bathroom for your Smart Mirror.
- Your WiFi network is already in high demand with streaming video and web surfing and you want to create a separate wireless network exclusively for your Smart Mirror.

Helpful hints once experiencing "buffering" on streaming content.

- Try to move your Wireless Access Point away from physical objects that can block your Wi-Fi signal - especially enclosed cabinets.
- Restart your network device (router, wap, extender etc.)
- Analyze which channel your Wi-Fi is using. You can do this with help Wi-Fi Analyzer app available in play store. Change your router setting in such a way that your channel is different from your neighbors Wi-Fi. The app itself shows recommendations for the channel.



Cleaning and Product Care

1. Use a soft damp cloth (cotton, flannel, etc.) and gently wipe the surface of the product. Wiping with a hard cloth or using strong force may scratch the surface of the product. Never touch, push, rub or strike the screen with any object.
2. Avoid using benzene, thinner and other solvents as they may deform the product and may cause the paint to peel off or damage the surface. Using a chemical cloth (wet/dry sheet type cloth, etc.) may cause damages and corrode the product. To avoid deformation, corrosion and color fading, wipe off water drops as soon as possible.
3. The following items may never be used for cleaning: solvents, cleaning petrol, scrubbing milk, spray cleaner, wax, acids, caustic solutions or the like. These agents may cause damages and corrode the product.

User Warranty

1. Warranty time.

Smart mirror -12 months. It guarantees that the Seller smart mirror (including the touch mirror, the screen, frame, and all built-in hardware elements (e.g., camera, processor) .

Body fat scales -12 months. Only if the customer requires the body fat scales with the mirror .

Installation - 1 month. For Seller smart mirror initially installed by authorized Seller technicians by Video guiding, If there is special project, Seller will offer door to door

2. Warranty process

- 1) When customer report a warranty case, it needs include the problem detail, when Seller get the case, Seller after service team needs the technical report. The report will be confirmed with both Seller technical team and customer's technical team. If it needs the special technical support from the third party, we will determine who will be responsible for the third party fee depends on the case.
- 2) When Seller confirm the warranty, Seller will follow the warranty steps, pls go to: How Seller do the warranty.
- 3) All of the order will be inspected before delivery in the Seller Factory, The customer needs to inspect again right after the goods arrive the port or arrive the customers' warehouse. Both part can negotiate those detail after the first 100 pcs orders.

Exclusion and limitation

Who is covered?

Distributors of the Seller smart mirror (collectively, the "device").

What's not included?

Any other Seller smart mirror from unauthorized distributors or resellers.

Software, even if sold with or embedded in a device, cannot be connected to the Internet. Seller smart mirror does not guarantee that the device will run without interruption or without errors. Due to improper or negligent assembly, maintenance (including beyond our suggest temperature range of use or storage equipment), installation, relocation or repair equipment malfunction or damage caused by the unauthorized service or installation technician), will this equipment is used with third party to provide spare parts or accessories, or with the original do not intend to use in the device or with the device of incompatible parts or accessories, or without the Seller mirror terms.

Any installation of the Seller smart mirror without Seller manual will void the Seller smart mirror and the limited warranty for labor and installation.

Due to accident, abuse, improper or abnormal use, negligence, corrosion, paint or plastic color (or any other appearance changes without affecting the performance), damage of equipment failures, theft, vandalism, fire, flood, wind, lightning, freezing or other natural disasters or any form of power is reduced, power fluctuations or power failure due to any reason, abnormal atmospheric conditions, collision, the introduction of foreign material or modified without Seller recommended.

Incidental or consequential loss. Seller assumes no liability for indirect, special, incidental or consequential loss, financial loss, loss of property or profit, loss of enjoyment or use, or indirect loss of any other nature relating to purchase, use, repair or maintenance of the equipment or parts. Seller does not provide monetary or other compensation for any such repair or replacement.

If you are a commercial buyer, use it for equipment that violates the terms of service or business procedures, for example, by not obtaining and paying a commercial subscription fee.

Any attempt to modify a device component or to modify, remove, add or install software not provided with the device or automatically updated by Seller or agree distributor will void the limited warranty.

Any relocation or attempted relocation after the initial installation of the Seller smart mirror. Any repairs or attempted repairs to the Seller smart mirror by anyone other than a Seller authorized technician.

Where permitted by law, replacement parts rearranged by Seller, parts and electronic components may sometimes be provided as warranty replacements and constitute warranty compliance.

This limited warranty is an exclusive warranty given by the Seller and supersedes any previous, contrary or other form of representation. Except to the extent prohibited by law, all other warranties, express or implied, include any statutory warranties or conditions of merchant ability. In this case, such warranty is limited to the above warranty period. Even if this limited warranty fails to serve its basic purpose, this warranty shall not apply whether due to tort, breach of contract, negligence or strict liability for tort, or under any other provision of law. Some jurisdictions do not allow the exclusion or limitation of incidental or secondary damage, so the above limitations may not apply to you. This limited warranty grants you certain legal rights, and you may have other legal rights as well.

How do I get warranty service?

To qualify for the services under this limited warranty, you must provide the Seller smart mirror with the serial number or other proof of purchase (indicating the date of purchase) upon discovery of any nonconformity or defect. If you think you need services, please contact us:

Claims must be made within the specified warranty period.

How Seller do the warranty?

1) If the problem can fix by replacement parts, Seller will send the replacement part together with new order to customer, if it is urgent and under agreement, Seller will send the replacement part separately, Seller will be responsible for the shipping fee.

2) If the problem cant fix by replacement parts, Seller will send new product with next order, if it is under agreement, Seller will refund the money to customer directly or use this money as next orders' deposit

3) If both side is under agreement, Seller can send the replacement part together with the order shipment base on some defective rate, this rate can be negotiated after formal orders or under the situation that both side can agree.

4) If there is urgent requirement from the customer, Seller can do the door to door support with agreement.

For more warranty method, it can be negotiated depends on the cooperation.

More options for warranty period?

It is our goal to be fully satisfied with your purchase within one year from the date of original purchase. We not only strive for your satisfaction, but also for your purchase enjoyment.

If you need more than 1 year guarantee such as 3 years or 5 years, we can negotiate for more details.

What if I have questions or doubts?

You can send any questions or concerns directly to the seller

Note: limited warranty claims

Any dispute between you and Seller in connection with this limited warranty or equipment will be governed by the dispute resolution procedures applicable at the time in the Mirrors terms of service.